

FORCEPS

Adson dissecting forceps

bayonet, 1-2 teeth, jaw 2.5mm at tip

SC-NEU/001c 191mm long



Adson dissecting forceps

bayonet, fine, serrated jaws, jaw 2.5mm at tip

SC-NEU/009 178mm long



Adson hypophyseal forceps

bayonet

SC-NEU/008 229mm long

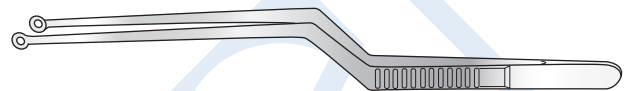

Scoville spatula forceps

with depth marking lines on blades

SC-NEU/016 13mm wide blade, 229mm long

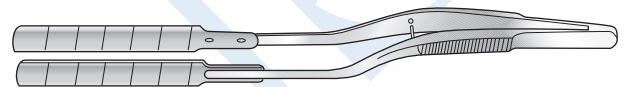

Jefferson dressing forceps

SC-NEU/013 serrated jaws, 178mm long



Jefferson dural forceps

SC-NEU/002 fine, 1-2 teeth, 178mm long



FORCEPS



Northfield dressing forceps

extra light, serrated jaws

SC-NEU/014 1mm wide, 203mm long

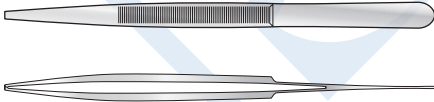

Pennybacker dissecting forceps

SC-NEU/005 3-4 teeth, 165mm long



Silcock iris forceps

102mm long

SC-NEU/006 1-2 teeth

SC-NEU/015 serrated jaws



Cairns dissecting forceps

delicate, 2-3 teeth

SC-NEU/003a 165mm long

SC-NEU/003b 216mm long



Cairns (Dott) dressing forceps

serrated jaws

SC-NEU/010 medium, 2mm wide, 216mm long

SC-NEU/012 fine, 1mm wide, 178mm long



Dott dural dissecting forceps

fine, 1-2 teeth

SC-NEU/004 178mm long

FORCEPS

Dott dressing forceps

angled

SC-NEU/018 114mm long

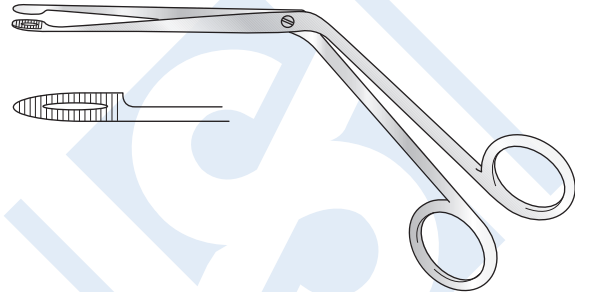

Olivecrona clip applying forceps

for applying Cushing-McKenzie clips, 210mm long

SC-NEU/090 straight jaws

SC-NEU/090a curved jaws

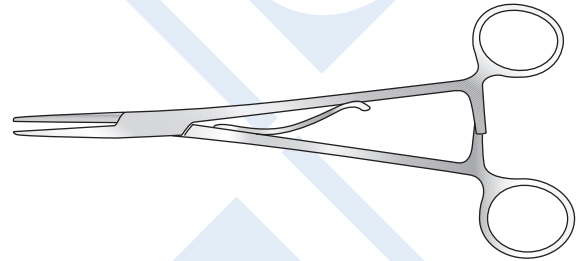

Olivecrona clip applying forceps

for applying Cushing-McKenzie clips

SC-NEU/090b crocodile, 140mm long

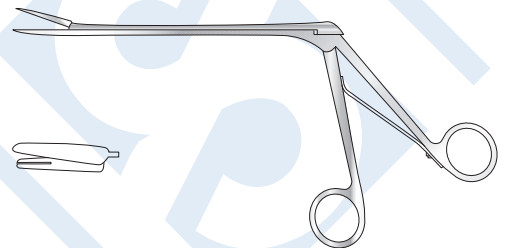

Sweet forceps

angular, crocodile, fine jaws

SC-NEU/019 1-2 teeth, 140mm long

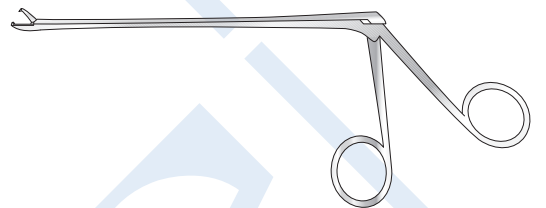

Tilley dressing forceps

angled, serrated ends

SC-NEU/017 89mm long

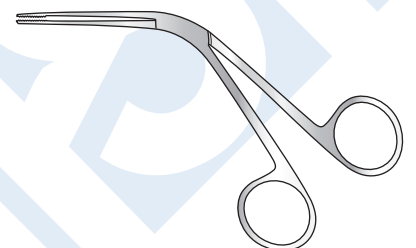

SCISSORS

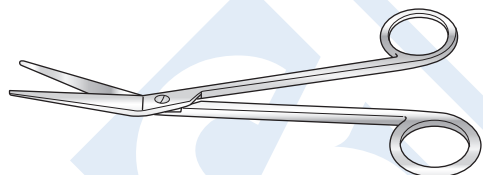

Cairns scissors

angled on flat

SC-NEU/020 178mm long

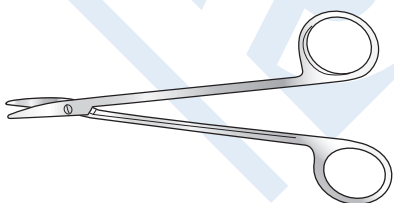

McKissock dural scissors

straight

SC-NEU/021a 146mm long

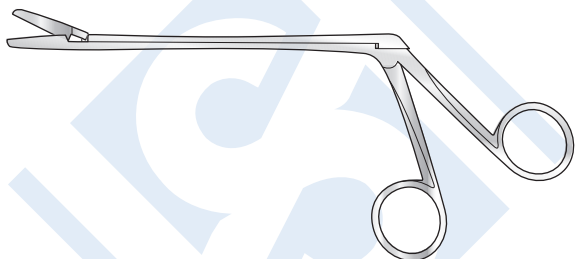

Olivecrona scissors

angled, with all micro serrated blade

SC-NEU/024 22mm blade, 150mm shaft

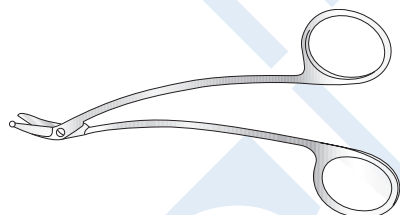

Schmieden (Taylor) dural scissors

angled, probe-pointed under blade

SC-NEU/023 146mm long

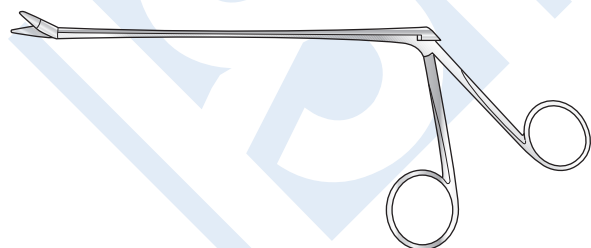

Sweet scissors

delicate

SC-NEU/025a 7mm blade, 144mm shaft

SC-NEU/030 13mm blade, 117mm shaft

DISSECTORS AND PROBES

Cairns dural guide and director

malleable

SC-NEU/080 127mm long



Dissector

200mm long

SC-NEU/N30210 soft

SC-NEU/N30220 soft, with hole

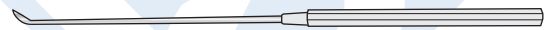

Penfield dissector

SC-NEU/069a No 1

broad curve, with 7.5mm sharp round spoon, 184mm long

SC-NEU/069b No 2

7.5mm sharp round spoon with wax packer, 178mm long

SC-NEU/069c No 3

full curve and wax packer, 197mm long

SC-NEU/069d No 4

slight curve, 4mm wide, 216mm long

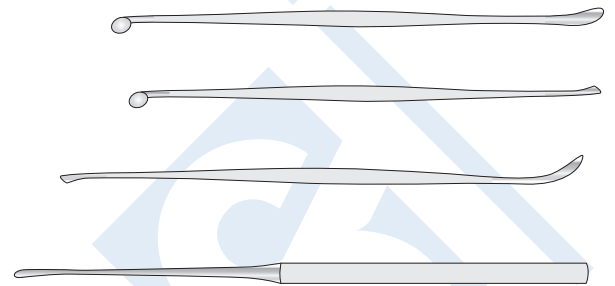

Pennybacker probe dissector

double ended

SC-NEU/101 229mm long



Swedish dissector

double ended

SC-NEU/100a light model, 178mm long

SC-NEU/100b heavy model, 200mm long



Watson Cheyne dissector

fine, double-ended, with probe end

SC-GI/287 127mm long

SC-GI/288 191mm long

SC-GI/288a 230mm long

SC-GI/288b 255mm long



CURETTES

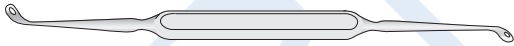

Falconer scoop curette

double ended, angled ends

SC-NEU/099 191mm long

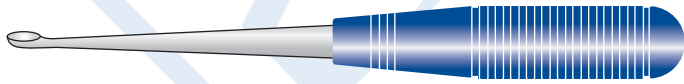

American spinal fusion curettes

Tufnol handles, 254mm long

Also available with acetel suregrip handle,
add suffix BH to catalogue number

straight

SC-NEU/074a	size 000	2mm x 4mm
SC-NEU/074b	size 00	2.5mm x 4.5mm
SC-NEU/074c	size 0	2.75mm x 5mm
SC-NEU/074d	size 1	3mm x 5.5mm
SC-NEU/074e	size 2	3.25mm x 6mm
SC-NEU/074f	size 3	4mm x 7mm
SC-NEU/074g	size 4	6mm x 9.5mm
SC-NEU/074h	size 5	7mm x 14mm
SC-NEU/074i	size 6	9mm x 17mm

angled

SC-NEU/074j	size 000	2mm x 4mm
SC-NEU/074k	size 00	2.5mm x 4.5mm
SC-NEU/074l	size 0	2.75mm x 5mm
SC-NEU/074m	size 1	3mm x 5.5mm
SC-NEU/074n	size 2	3.25mm x 6mm
SC-NEU/074o	size 3	4mm x 7mm
SC-NEU/074p	size 4	6mm x 9.5mm
SC-NEU/074q	size 5	7mm x 14mm
SC-NEU/074r	size 6	9mm x 17mm

HOOKS

Adson hook

178mm long

- SC-NEU/078a** angled
- SC-NEU/078b** straight
- SC-NEU/078b-b** straight, blunt



Adson Oliver neuro hook

191mm long

- SC-NEU/082a** angled downward, blunt
- SC-NEU/082b** sharp
- SC-NEU/082c** angled upward, blunt

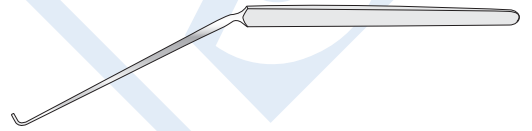

Cairns dural hook

127mm long

- SC-NEU/081b** half round, sharp
- SC-NEU/081c** angled, sharp



Oliver dural hook

blunt

- SC-NEU/081a** 127mm long



Meninges hook

- SC-NEU/N20340** 160mm long



Meninges hook

sharp

- SC-NEU/NA5080** 150mm long



RETRACTORS

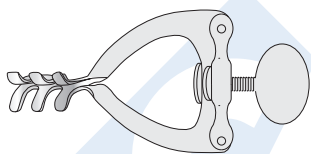

Mastoid retractor

3 x 3 blunt hooks

SC-NEU/N30350 114mm long

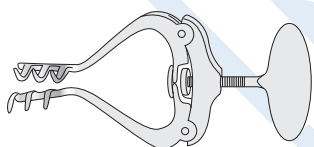

Jansen (Shea) retractor

self retaining, blunt blades

SC-NEU/028 114mm long

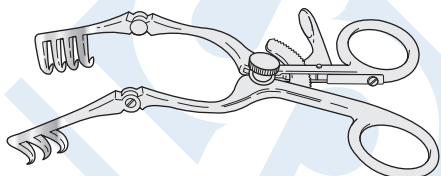

Cone retractor

self retaining, hinged arms, for use in ventriculography

SC-NEU/027 165mm long

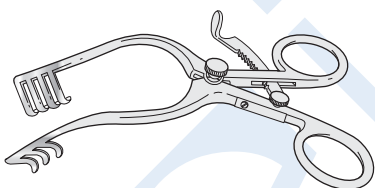

Jefferson retractor

self retaining, curved, blunt pointed blades

SC-NEU/029 140mm long

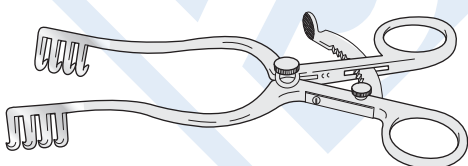

Henderson retractor

self retaining, straight, 4 x 4 blunt pointed blades

SC-NEU/030a 178mm long

RETRACTORS

Cairns scalp retractor

curved, self retaining, swivel blades

SC-NEU/025b 140mm long

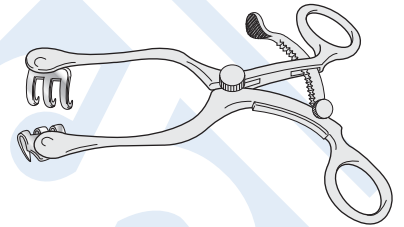

Schnitker scalp retractor

curved, self retaining, blunt swivel blades

SC-NEU/026 140mm long

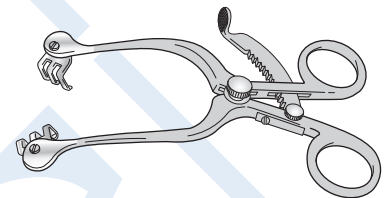

Cone laminectomy retractor

hinged arms, with cam rack

SC-NEU/051 254mm long

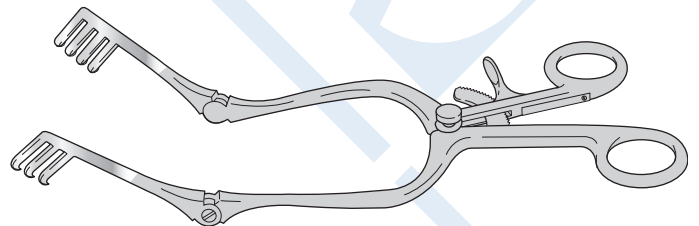

Cone laminectomy retractor

hinged arms

SC-NEU/052a left, 165mm long

SC-NEU/052b right, 165mm long

SC-NEU/052c left, 254mm long

SC-NEU/052d right, 254mm long

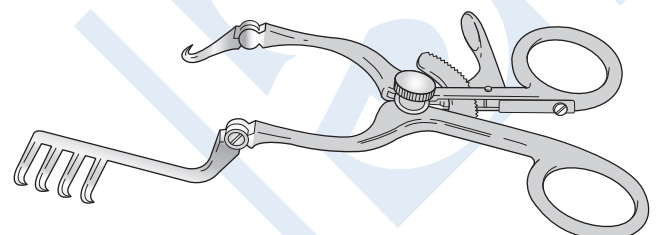

RETRACTORS

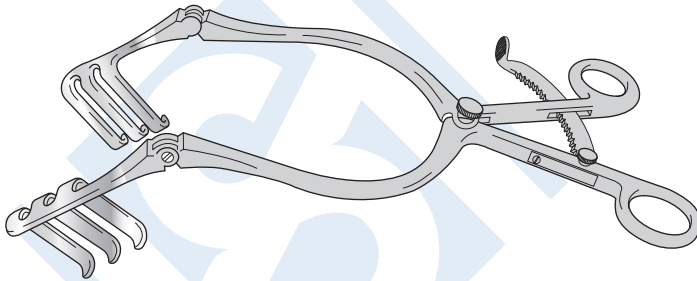

Harvey-Jackson laminectomy retractor
hinged arms, blades 38mm wide x 44mm deep

SC-NEU/053 305mm long

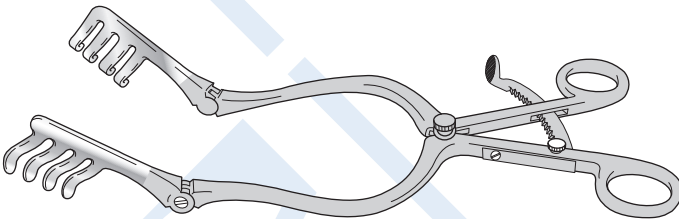

Mayo-Adson (Beckmann) laminectomy retractor
hinged arms

SC-NEU/054 292mm long

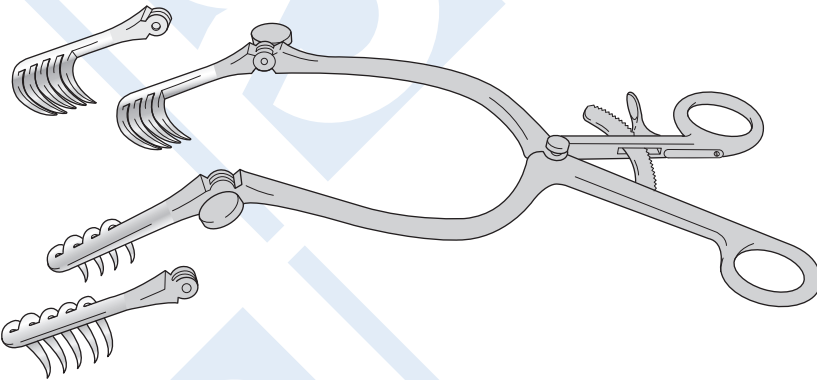

Northfield (Cairns) retractor
292mm long

SC-NEU/055
hinged arms,
one pair of blades,
4 prong,
25mm wide x 16mm deep
and one pair of blades,
5 prong,
32mm wide x 25mm deep

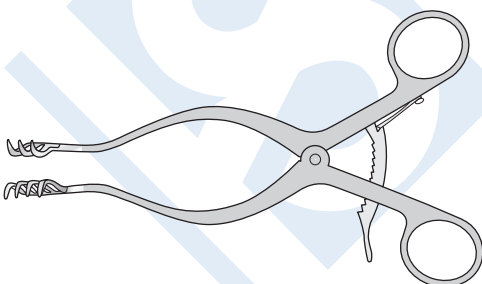

Mastoid retractor
180mm long

SC-NEU/NG0080
3 x 4 blunt hook

RETRACTORS

Cairns-Northfield laminectomy retractor

203mm arm length

SC-NEU/036

with three pairs of interchangeable swivelling blades, 76mm, 64mm, and 51mm

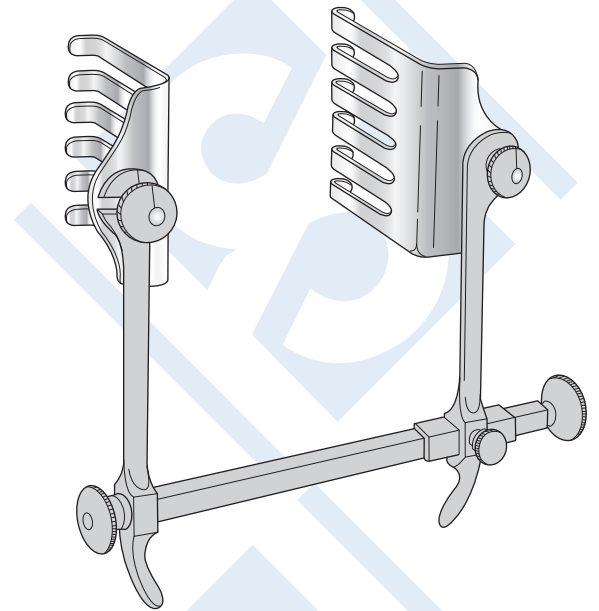

Cairns 'rake' scalp retractor

sharp, 210mm long

SC-NEU/032a 3 prong, 16mm wide

SC-NEU/032b 4 prong, 19mm wide

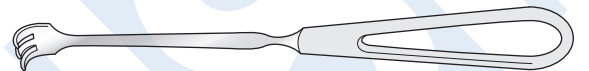

Cairns (Cushing) scalp retractor

solid blade

SC-NEU/033 16mm wide, 210mm long

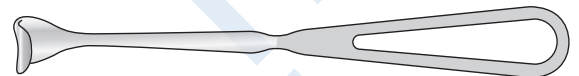

Cairns strip retractor

malleable, 203mm long

8 sizes: 6, 8, 10, 11, 13, 16, 19, 25mm

SC-NEU/034a 20 SWG

SC-NEU/034b 18 SWG



Hibbs retractor

203mm long

SC-NEU/050a blades 10mm x 38mm

SC-NEU/050b blades 16mm x 54mm

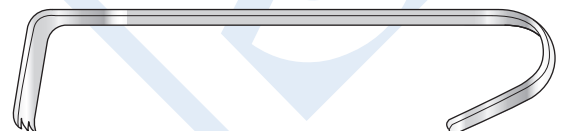

RETRACTORS AND ELEVATORS

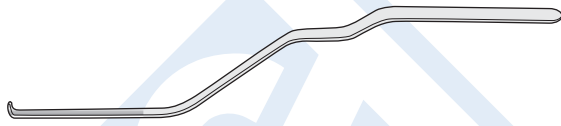

Krayenbuhl root retractor

6mm wide

SC-NEU/5905 210mm long

SC-NEU/5905a 240mm long

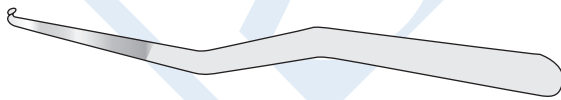

Love root retractor

6mm wide

SC-NEU/5905b 210mm long

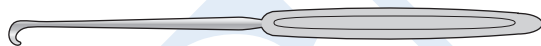

Love root retractor

203mm long

SC-NEU/077a straight, blade 5mm x 5mm

SC-NEU/077b shaft angled 90° at handle

SC-NEU/077c shaft angled 45° at handle

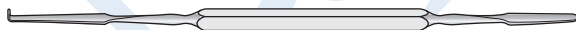

O'Connell root retractor

double ended

SC-NEU/076 216mm long

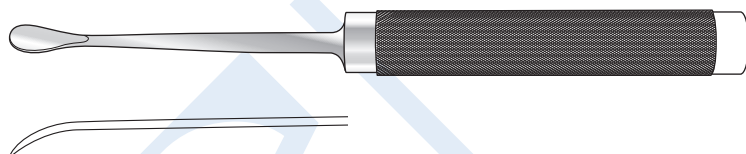

Cobb spinal elevator

13mm wide, knurled handle

SC-NEU/073e 279mm long



Cobb spinal elevator

with Tufnol handles, 279mm long

Also available with acetal suregrip handle,
add suffix BH to catalogue number

SC-NEU/073a 10mm wide

SC-NEU/073b 13mm wide

SC-NEU/073c 19mm wide

ELEVATORS

Adson periosteal elevator

serrated grip, 165mm long

straight

SC-OR/N028 7mm wide

curved

SC-OR/N029 5mm wide

SC-OR/N030 7mm wide

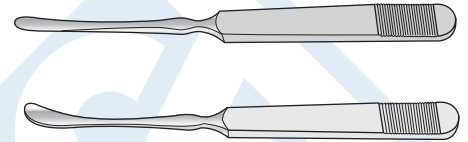

Cairns skull flap elevator

SC-NEU/065 178mm long

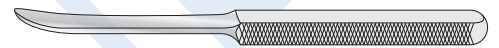

Cushing periosteal elevator

slightly curved end

SC-NEU/071 197mm long



Horsley dura mater elevator

SC-NEU/079 178mm long

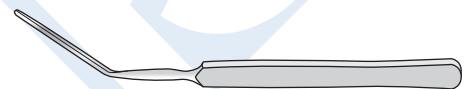

McKissock spade periosteal elevator

straight

SC-NEU/072 197mm long



Pennybacker elevator

curved, sharp, 171mm long

SC-OR/N025 6mm wide

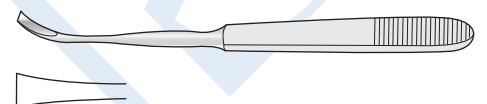

SUCTION TUBES



Adson Frazier suction tube
angled, fully insulated, 180mm long

SC-NEU/094b 7 F.G.
SC-NEU/094c 8 F.G.
SC-NEU/094d 9 F.G.



Adson suction tube
with slight curve

SC-NEU/095 10 F.G. 156mm long

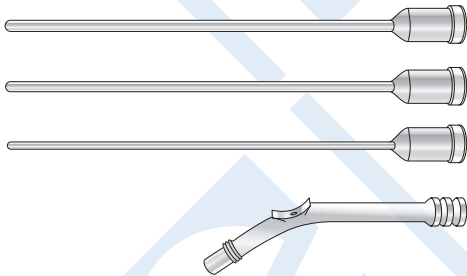

Cone suction tubes

SC-NEU/096 set of three with screw mount fitting, one curved handle, and tucker valve

Cone suction tubes

with screw mount, to fit curved handle, 178mm long

SC-NEU/097a 3mmø
SC-NEU/097b 4mmø
SC-NEU/097c 5mmø

Cone suction tube handle

curved, with tucker valve

SC-NEU/098 102mm long

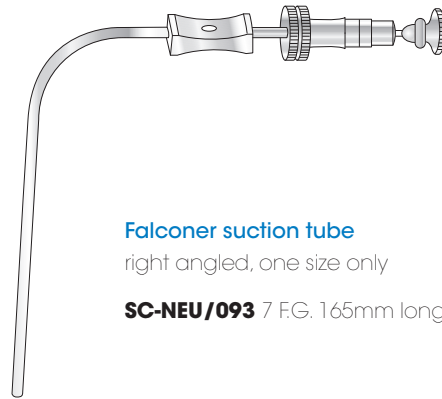

Falconer suction tube
right angled, one size only

SC-NEU/093 7 F.G. 165mm long

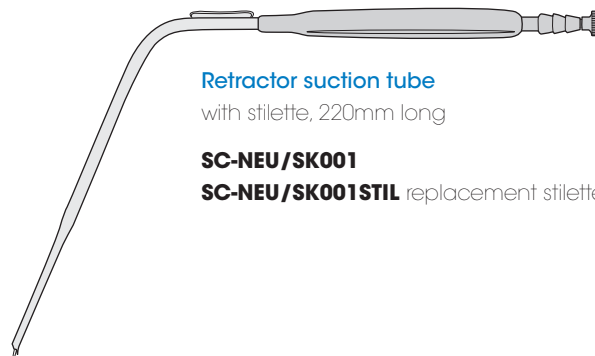

Retractor suction tube
with stilette, 220mm long

SC-NEU/SK001
SC-NEU/SK001STIL replacement stilette

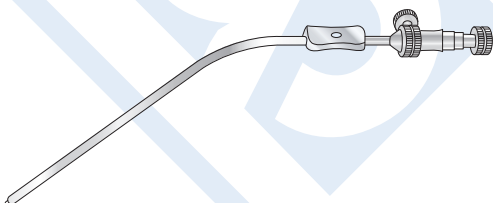

Frazier suction tubes

malleable, silver, angled, 180mm long

SC-NEU/092a 7 F.G.
SC-NEU/092b 8 F.G.
SC-NEU/092c 9 F.G.

SUCTION TUBES

Bateman rongeur
flattened distal blade

SC-NEU/124 3mm bite, 40° angle, 152mm long

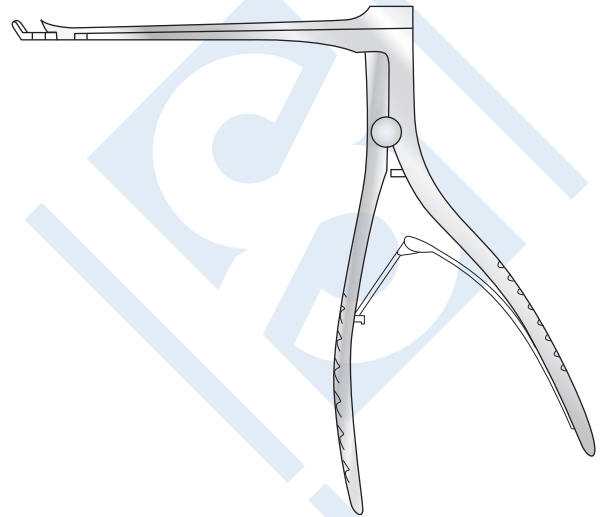

Falconer rongeur
oblique jaws

SC-NEU/122a upward cutting, 3mm bite, 110mm shaft

SC-NEU/122b upward cutting, 5mm bite, 110mm shaft

SC-NEU/122c downward cutting, 3mm bite, 85mm shaft

SC-NEU/122d downward cutting, 5mm bite, 110mm shaft

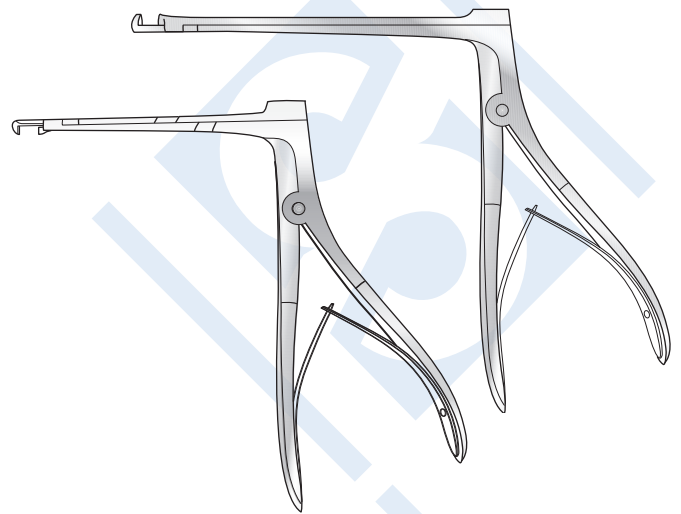

Dandy's rongeur
straight

SC-NEU/134 3mm bite, 178mm shaft

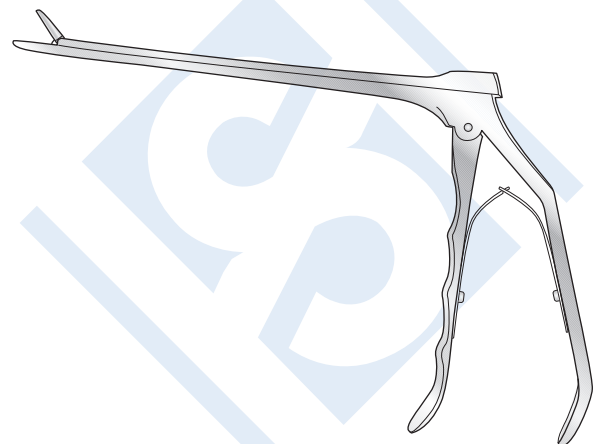

RONGEURS

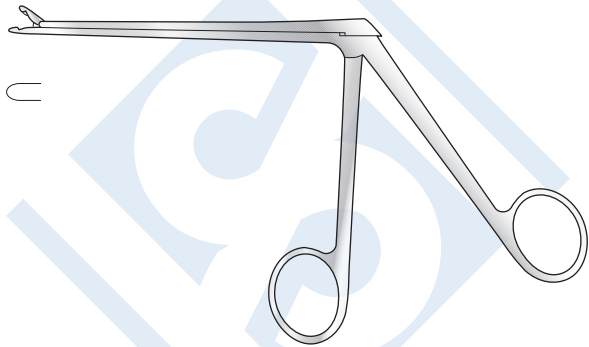

Beck rongeur

straight, for intervertebral disc

SC-NEU/125 2mm bite, 130mm shaft

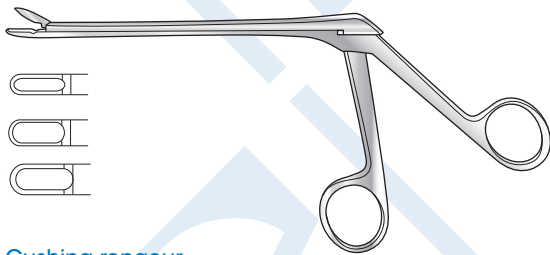

Cushing rongeur

130mm shaft

- SC-NEU/127-2** 2mm bite
- SC-NEU/127-3** 3mm bite
- SC-NEU/127-4** 4mm bite
- SC-NEU/127-5** 5mm bite
- SC-NEU/127-6** 6mm bite



Cushing rongeur

130mm shaft

150° upward cutting

- SC-NEU/128c** 2mm bite
- SC-NEU/128** 3mm bite
- SC-NEU/128a** 4mm bite
- SC-NEU/128b** 5mm bite

150° downward cutting

- SC-NEU/130c** 2mm bite
- SC-NEU/130** 3mm bite
- SC-NEU/130a** 4mm bite
- SC-NEU/130b** 5mm bite

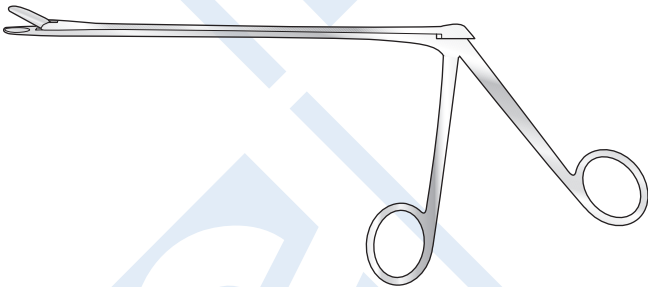

Love-Grunwald rongeur

cup shaped, jaws 3mm x 10mm, 178mm shaft

- SC-NEU/131a** straight
- SC-NEU/131b** curved upward
- SC-NEU/131c** curved downward

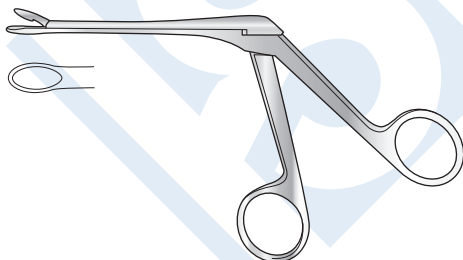

Mackay rongeur

140°, straight, 114mm shaft

SC-SH/4249 5.5mm

RONGEURS

Northfield rongeur

curved, upward cutting

SC-NEU/132 4mm bite, 133mm shaft

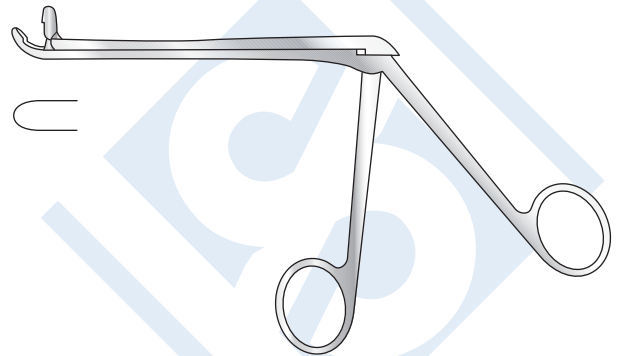

Pennybacker rongeur

120mm shaft

SC-NEU/133 3mm bite

SC-NEU/133-4 4mm bite

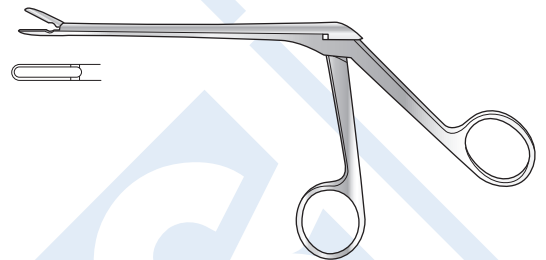

St Barts rongeur

114mm shaft

SC-ENT/140a 3mm bite

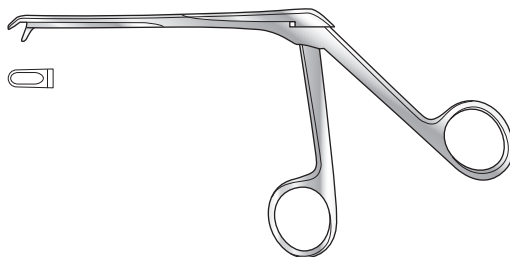
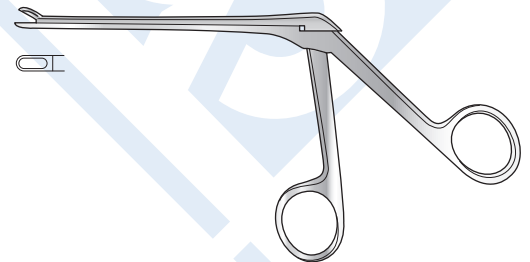

St Barts rongeur

140°, downward cutting, 114mm shaft

SC-ENT/140ac 3mm

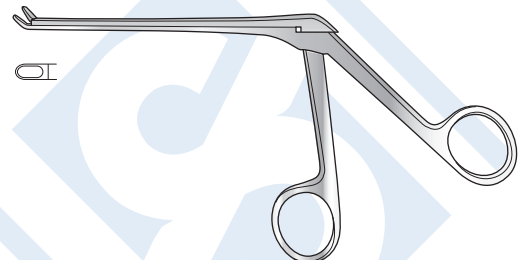

St Barts rongeur

140°, upward cutting, 114mm shaft

SC-ENT/140b 3mm

RONGEURS

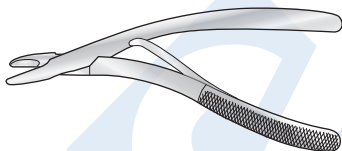

Daniel rongeur

miniature, for neuro-pathology

SC-NEU/104 1.5mm bite, 127mm long

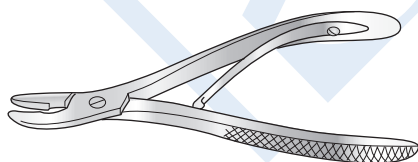

Cairns rongeur

fine jaws, angled on flat,
serrated jaws, curved handles

SC-NEU/103

4mm bite 152mm long

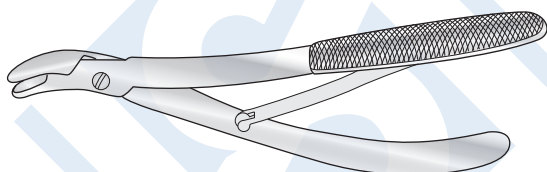

Danish pattern rongeur

angled on flat, fine jaws, curved handles, screw joint

SC-NEU/109 4mm bite, 203mm long

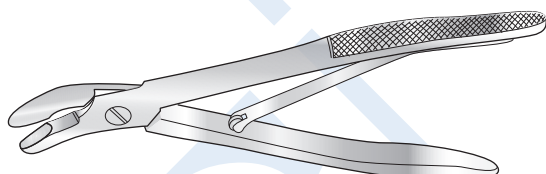

Falconer rongeur

angled to side, light, screw joint

SC-NEU/110 6mm bite, 203mm long

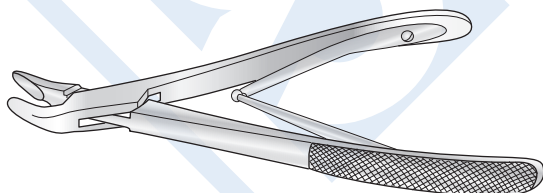

Wilms rongeur

angled on flat, narrow jaws

SC-NEU/114 4mm bite, 203mm long

RONGEURS

Glasgow pattern rongeur

slightly curved on flat, screw joint

SC-NEU/111 4mm bite, 146mm long

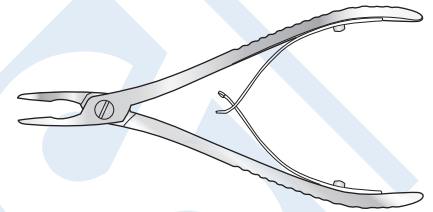

Heanley rongeur

long fine straight jaws, screw joint

SC-NEU/112 4mm bite, 178mm long

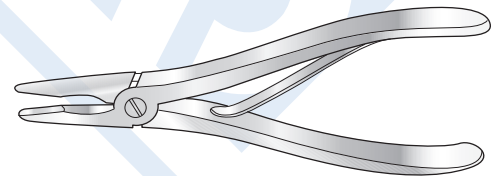

Jansen rongeur

short curve, screw joint

SC-NEU/105 8mm bite, 152mm long

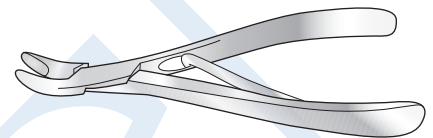

Pennybacker rongeur

straight, fine jaws, 203mm long

SC-NEU/107 4mm bite

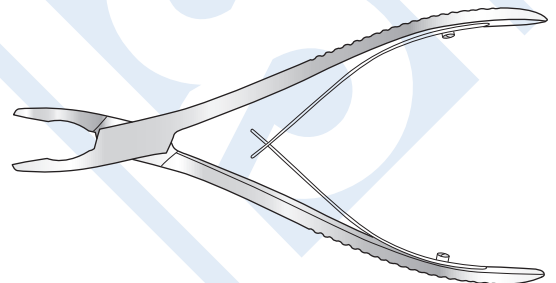

Northfield rongeur

straight, 10mm bite

SC-NEU/106 one shallow blade, 200mm long

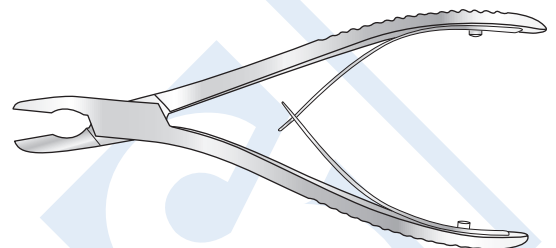

Stokey rongeur

angled to side, fine jaws

SC-NEU/108 3mm bite, 178mm long

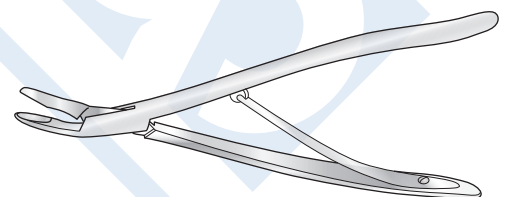

RONGEURS

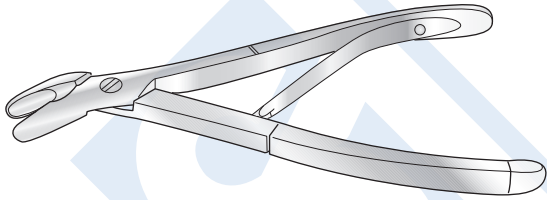

Trotter rongeur

angled to side, strong, screw joint

SC-NEU/113 10mm bite, 203mm long

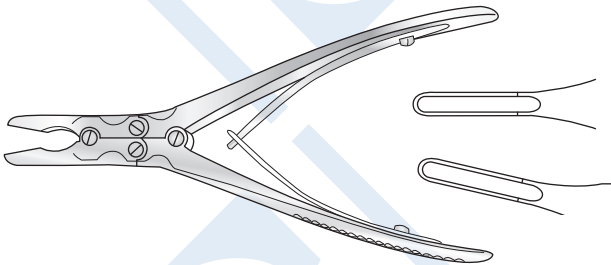

Luer-Jansen rongeur

light, curved on flat, compound action

SC-NEU/116 4mm bite, 197mm long

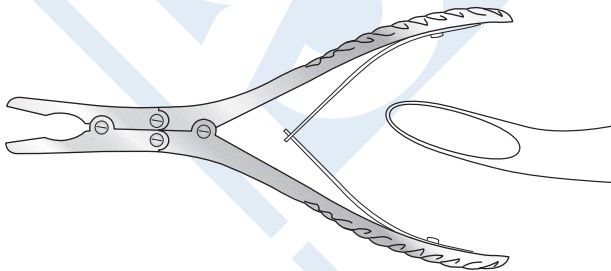

Ruskin rongeur

curved on flat, compound action

SC-NEU/118 6mm bite, 184mm long

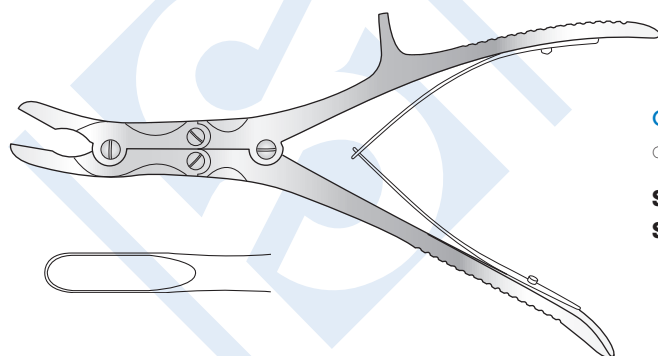

Olivecrona rongeur

angled to side, compound action, 229mm long

SC-NEU/119a 5mm bite

SC-NEU/119b 6mm bite

RONGEURS

Leksell rongeur

curved to side, compound action

SC-NEU/115a small, 6mm bite, 229mm long

SC-NEU/115b large, 8mm bite, 254mm long

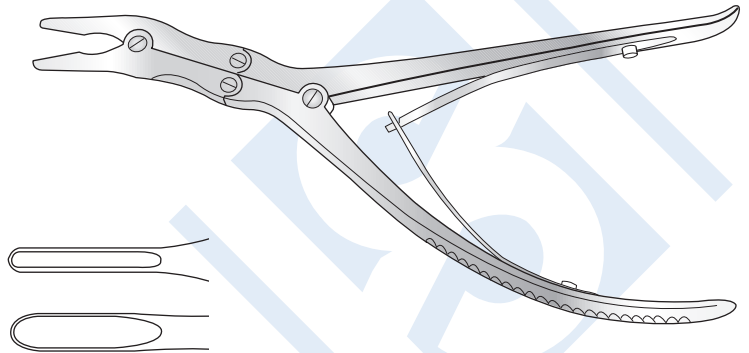

Luer Stille bone rongeur

curved, 250mm long

SC-OR/071b 11mm bite

SC-NEU/117 heavy, 229mm long

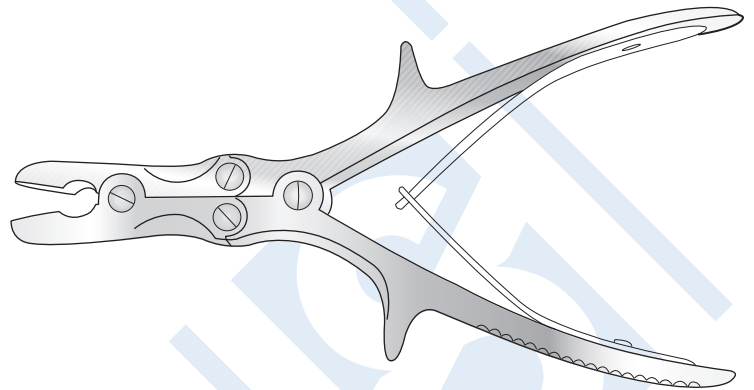
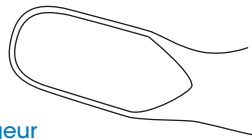

Swedish pattern laminectomy shears

double crank, compound action

SC-NEU/121 267mm long

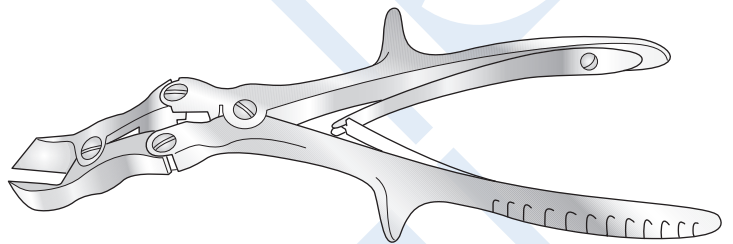

De Vilbiss skull channelling forceps

SC-NEU/120 225mm long

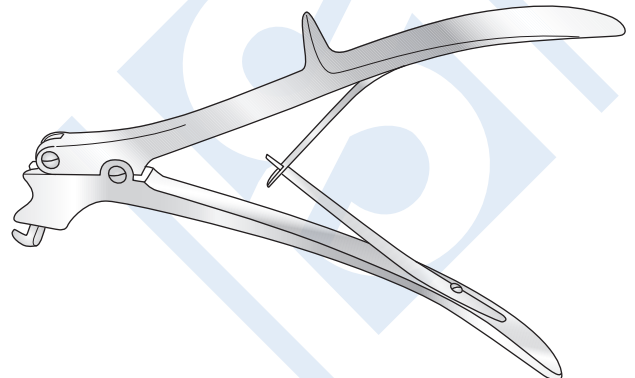

PUNCHES

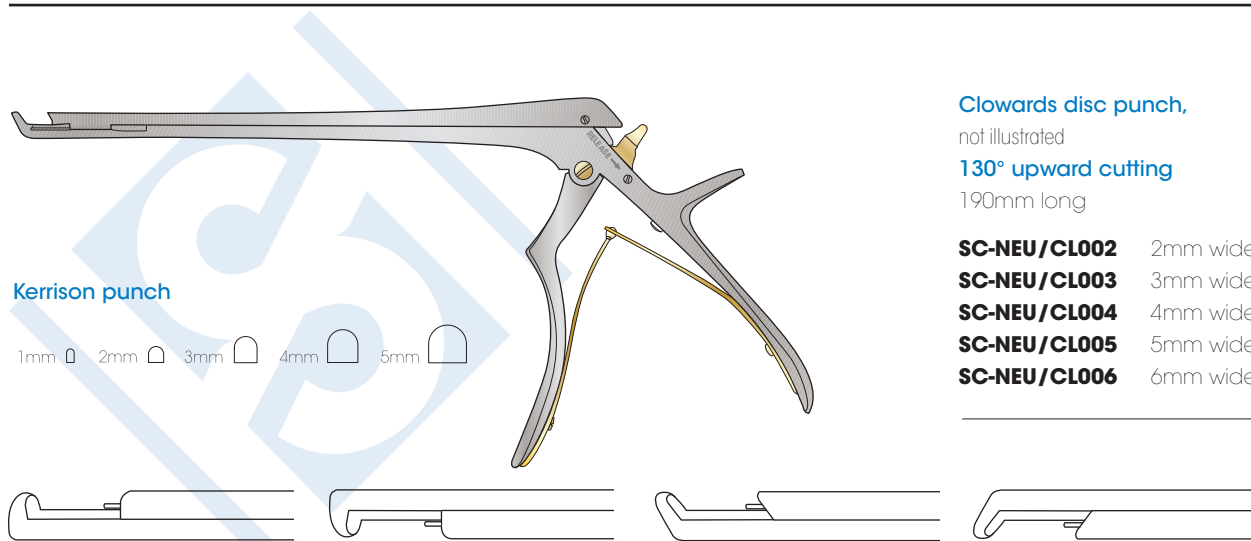

Clowards disc punch,
not illustrated
130° upward cutting
190mm long

- SC-NEU/CL002** 2mm wide
- SC-NEU/CL003** 3mm wide
- SC-NEU/CL004** 4mm wide
- SC-NEU/CL005** 5mm wide
- SC-NEU/CL006** 6mm wide

NON-DETACHABLE

90° upward cutting			downward cutting			130° upward cutting			downward cutting		
	LENGTH mm	WIDTH mm		LENGTH mm	WIDTH mm		LENGTH mm	WIDTH mm		LENGTH mm	WIDTH mm
SC-NEU/136	180	1	SC-NEU/154	180	1	SC-NEU/172	180	1	SC-NEU/198	180	1
SC-NEU/137	180	2	SC-NEU/155	180	2	SC-NEU/173	180	2	SC-NEU/199	180	2
SC-NEU/138	180	3	SC-NEU/156	180	3	SC-NEU/174	180	3	SC-NEU/200	180	3
SC-NEU/139	180	4	SC-NEU/157	180	4	SC-NEU/175	180	4	SC-NEU/201	180	4
SC-NEU/140	180	5	SC-NEU/158	180	5	SC-NEU/176	180	5	SC-NEU/202	180	5
SC-NEU/141	230	2	SC-NEU/159	230	2	SC-NEU/177	200	3	SC-NEU/203	230	2
SC-NEU/142	230	3	SC-NEU/160	230	3	SC-NEU/178	200	4	SC-NEU/204	230	3
SC-NEU/143	230	4	SC-NEU/161	230	4	SC-NEU/179	200	5	SC-NEU/205	230	4
SC-NEU/144	230	5	SC-NEU/162	230	5	SC-NEU/180	200	6	SC-NEU/206	230	5
						SC-NEU/181	230	2			
						SC-NEU/182	230	3			
						SC-NEU/183	230	4			
						SC-NEU/184	230	5			

DETACHABLE

90° upward cutting			downward cutting			130° upward cutting			downward cutting		
	LENGTH mm	WIDTH mm		LENGTH mm	WIDTH mm		LENGTH mm	WIDTH mm		LENGTH mm	WIDTH mm
SC-NEU/145	180	1	SC-NEU/163	180	1	SC-NEU/185	180	1	SC-NEU/207	180	1
SC-NEU/146	180	2	SC-NEU/164	180	2	SC-NEU/186	180	2	SC-NEU/208	180	2
SC-NEU/147	180	3	SC-NEU/165	180	3	SC-NEU/187	180	3	SC-NEU/209	180	3
SC-NEU/148	180	4	SC-NEU/166	180	4	SC-NEU/188	180	4	SC-NEU/210	180	4
SC-NEU/149	180	5	SC-NEU/167	180	5	SC-NEU/189	180	5	SC-NEU/211	180	5
SC-NEU/150	230	2	SC-NEU/168	230	2	SC-NEU/190	200	3	SC-NEU/212	230	2
SC-NEU/151	230	3	SC-NEU/169	230	3	SC-NEU/191	200	4	SC-NEU/213	230	3
SC-NEU/152	230	4	SC-NEU/170	230	4	SC-NEU/192	200	5	SC-NEU/214	230	4
SC-NEU/153	230	5	SC-NEU/171	230	5	SC-NEU/193	200	6	SC-NEU/215	230	5
						SC-NEU/194	230	2			
						SC-NEU/195	230	3			
						SC-NEU/196	230	4			
						SC-NEU/197	230	5			

MISCELLANEOUS

**Blackburn
skull traction apparatus**

SC-NEU/137

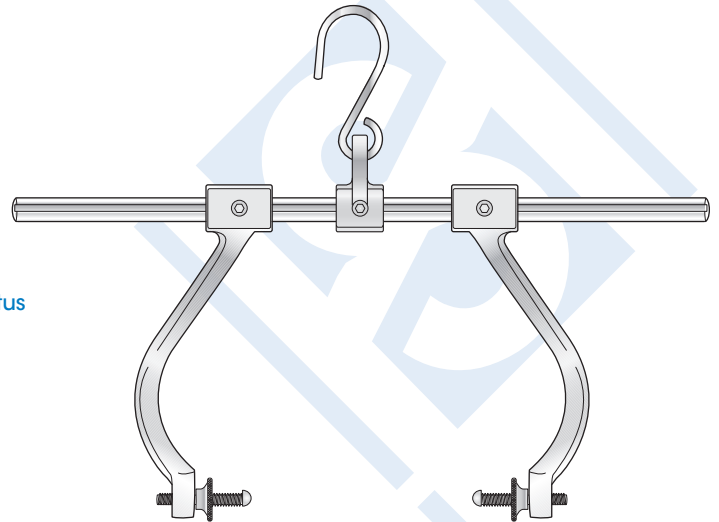

Crutchfield skull traction tongs

SC-NEU/136

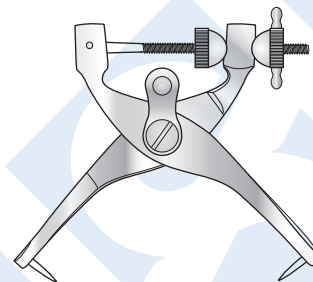

Capener lamina gouge

cranked, Tufnol handle, 250mm long
OTHER LENGTHS AND SIZES AVAILABLE

- SC-OR/373c** width 6mm
- SC-OR/373d** width 8mm
- SC-OR/373e** width 11mm
- SC-OR/373f** width 16mm

Also available with acetal suregrip handle, add suffix BH to catalogue number

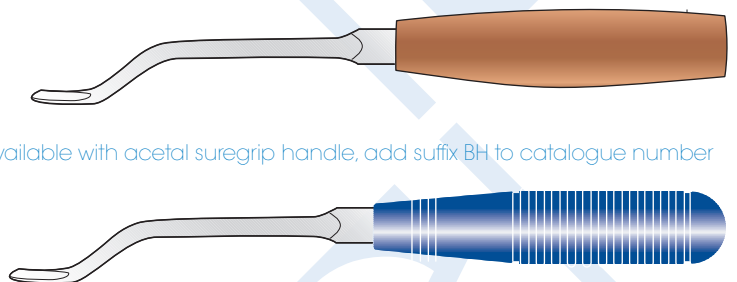

Hudson brace

265mm long

- SC-NEU/057a** standard
- SC-NEU/057b** small
- SC-NEU/061** extension piece 127mm long

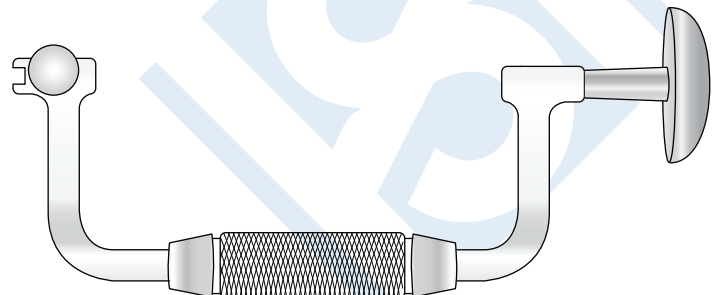

MISCELLANEOUS

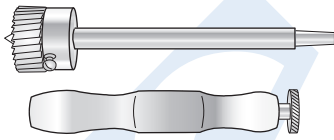

Horsley's trephine
with handle, 127mm long

SC-NEU/056
6.35mmø, 10mmø, 13mmø, 19mmø, 25mmø, 32mmø, 38mmø

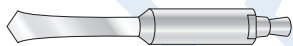

Hudson perforator
original model

108mm long	102mm long
SC-NEU/057c 10mm	SC-NEU/058a 10mm
SC-NEU/057d 12mm	SC-NEU/058b 12mm
SC-NEU/057e 15mm	SC-NEU/058c 15mm



Hudson conical burr
114mm long

SC-NEU/059a 9mmø
SC-NEU/059b 11mmø
SC-NEU/059c 13mmø
SC-NEU/059d 16mmø



Hudson spherical burr
92mm long

SC-NEU/060a 11mmø
SC-NEU/060b 13mmø
SC-NEU/060c 16mmø
SC-NEU/060d 19mmø
SC-NEU/060e 22mmø

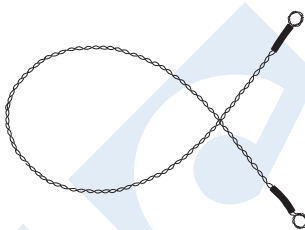

Charnley saws
SC-OR/10c 500mm long
SC-OR/11c 700mm long

Gigli saws
SC-OR/09 300mm long
SC-OR/10 500mm long
SC-OR/11 700mm long

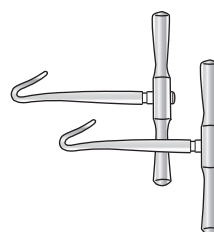

Gigli saw handles
per pair
SC-OR/08 65mm long



Cairns de Martel Gigli saw guide protector
SC-NEU/064 305mm long