

thoracic

forceps	PAGE 285
clamps	PAGE 288
scissors	PAGE 291
needle holders	PAGE 292
retractors	PAGE 293
rib spreaders	PAGE 294
rib shears	PAGE 297
elevators	PAGE 298
miscellaneous	PAGE 298

FORCEPS

Duval lung grasping forceps

SC-THO/033 185mm long

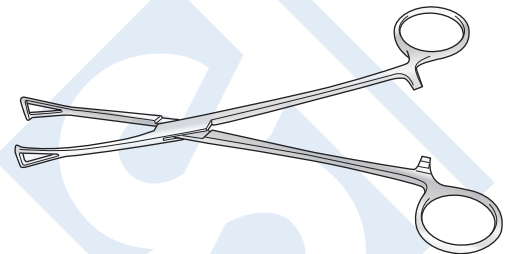

Babcock lung grasping forceps

SC-THO/034 245mm long

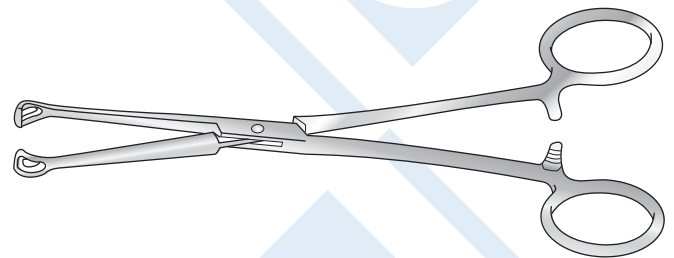

O'Shaughnessy artery forceps

right angled serrated jaw

SC-THO/036a 150mm long

SC-THO/036b 180mm long

SC-THO/036c 200mm long

SC-THO/036d 230mm long

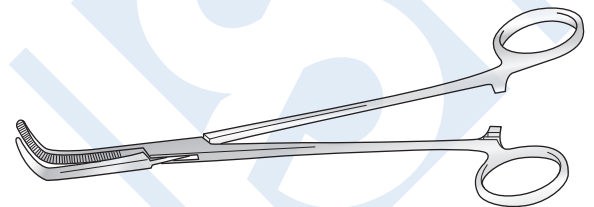

Tudor Edwards artery forceps

curved, serrated jaws, screw joint, satin finish

SC-THO/015 230mm long

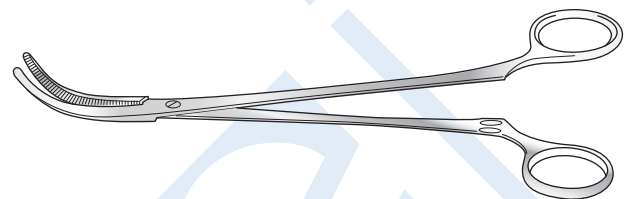

Roberts artery forceps

curved on flat, serrated jaws, screw joint, satin finish

SC-THO/016 230mm long

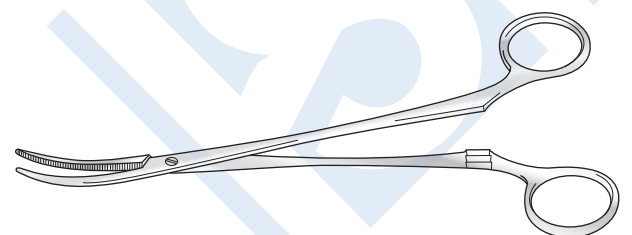

FORCEPS

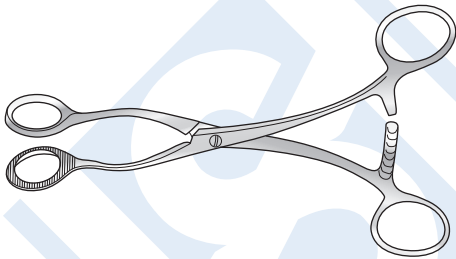

Collin tongue holding forceps
straight

SC-THO/031 170mm long

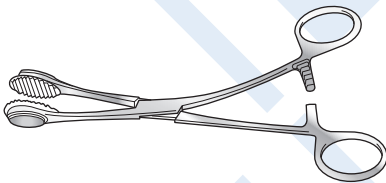

Young's tongue holding forceps
straight

SC-THO/030 140mm long

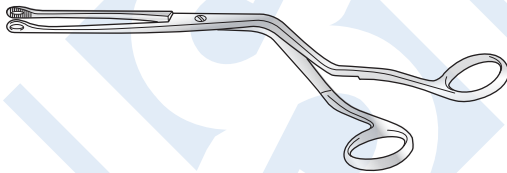

Magill intratracheal catheter forceps
screw joint

SC-THO/032 infant, 160mm long
SC-THO/032a child, 190mm long
SC-THO/032b adult, 230mm long

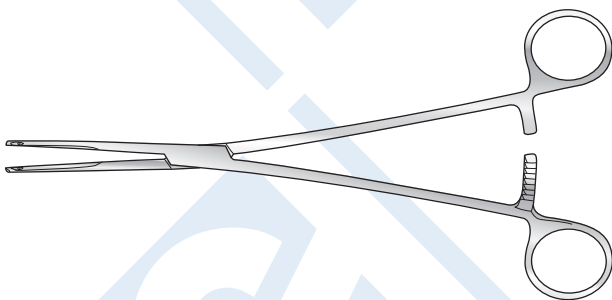

Semb ligature passing forceps
240mm long

SC-THO/044 slightly curved
SC-THO/045 fully curved

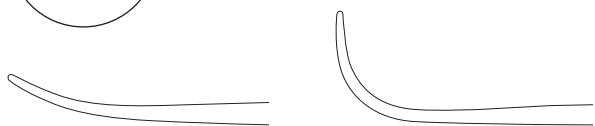
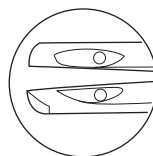

ATRAUMATIC FORCEPS

Debakey atraumatic dissecting forceps

straight, non traumatic jaws

1.5mm

- SC-GI/238a** 150mm long
- SC-GI/239a** 196mm long
- SC-GI/240a** 240mm long
- SC-GI/241a** 180mm long

2mm

- SC-GI/238** 150mm long
- SC-GI/239** 196mm long
- SC-GI/240** 240mm long
- SC-GI/241** 180mm long

2.5mm

- SC-GI/238b** 150mm long
- SC-GI/239b** 196mm long
- SC-GI/240b** 240mm long
- SC-GI/241b** 180mm long

2.8mm

- SC-GI/238c** 150mm long
- SC-GI/239c** 196mm long
- SC-GI/240c** 240mm long
- SC-GI/241c** 180mm long

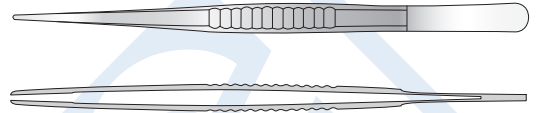
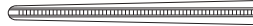

Derra forceps

curved, atraumatic, haemostatic, 170mm long

- SC-THO/022a** 15mm jaw
- SC-THO/022b** 20mm jaw
- SC-THO/022c** 325mm jaw

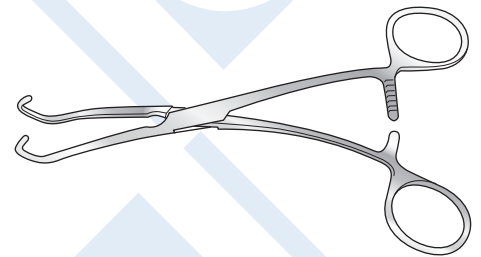

Satinsky forceps

curved, atraumatic, haemostatic, jaw is measured over straight section 265mm long

- SC-THO/022d** 30mm jaw
 - SC-THO/022e** 40mm jaw
 - SC-THO/022f** 50mm jaw
- OTHER LENGTHS AVAILABLE

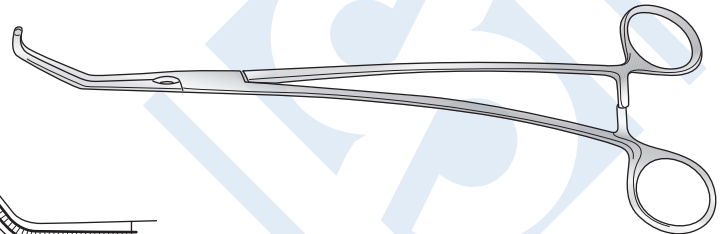
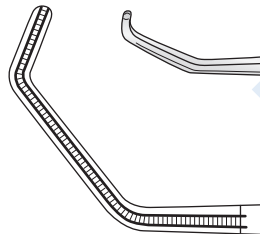

Debakey Bainbridge forceps

haemostatic, atraumatic

180mm long

- SC-THO/021a** straight
- SC-THO/021b** curved

155mm long

- SC-THO/026a** straight
- SC-THO/026b** curved

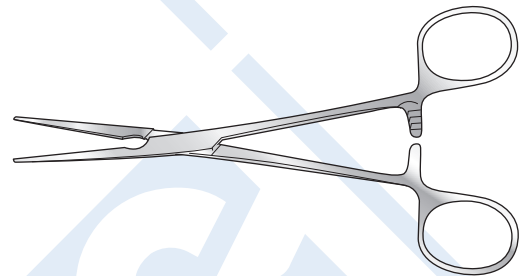

Lambert-Kay forceps

atraumatic

- SC-THO/029a** curved, 220mm long
- SC-THO/029b** straight, 215mm long
- SC-THO/029c** straight, 200mm long

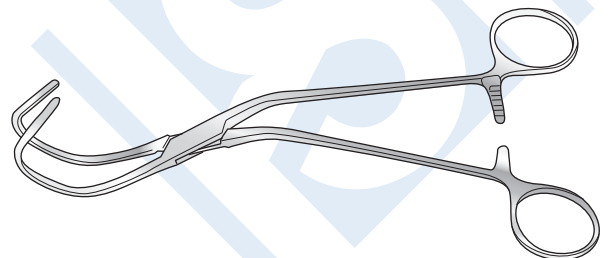

ATRAUMATIC FORCEPS / CLAMPS

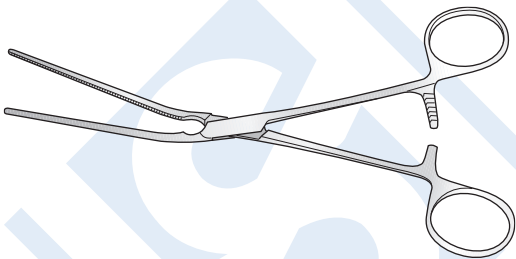

Leland-Jones forceps

atraumatic, hemostatic

SC-THO/023a curved, 190mm long

SC-THO/023b straight, 195mm long

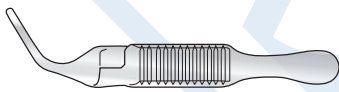

Diethrich bulldog clamp

angled 12mm jaw

SC-JD-GI/8097 44mm long

SHOWN FULL SIZE - OTHER SIZES AVAILABLE

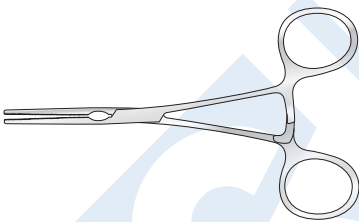

Debaquey classic bulldog clamp

straight jaws, ring handle

SC-THO/048 137mm long

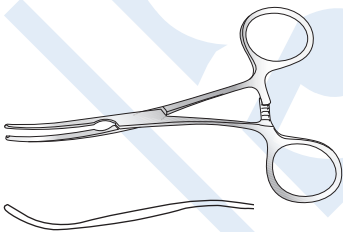

Debaquey classic bulldog clamp

'S' shaped curved jaws, curved shaft,
ring handle

SC-THO/049 127mm long

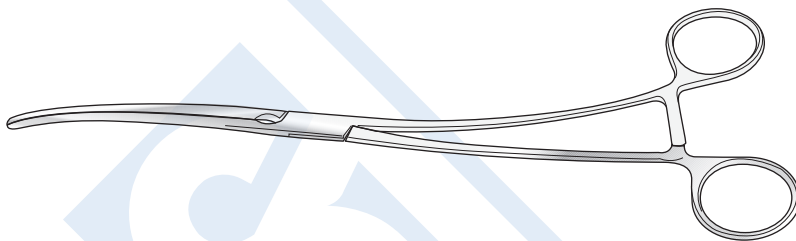

Debaquey "S" shaped clamp

300mm long

SC-THO/096 115mm jaws



ATRAUMATIC CLAMPS

Debakey atraumatic clamp

SC-THO/090 110mm jaw, 300mm long

SC-THO/092 95mm jaw, 250mm long

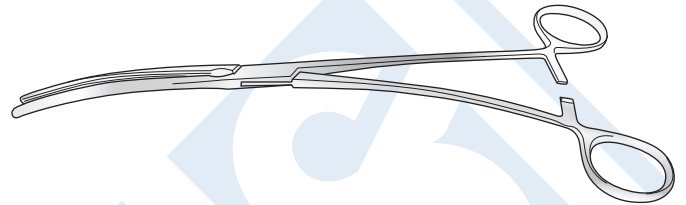

Debakey atraumatic clamp

right-angled, 40mm jaw

SC-THO/044a 220mm long

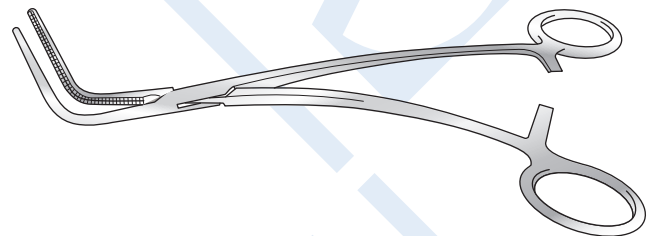

Debakey atraumatic clamp

right-angled, 50mm jaw

SC-THO/045 200mm long

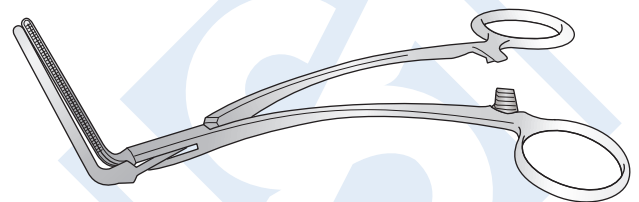

Debakey atraumatic clamp

right-angled, 65mm jaw

SC-THO/046 215mm long

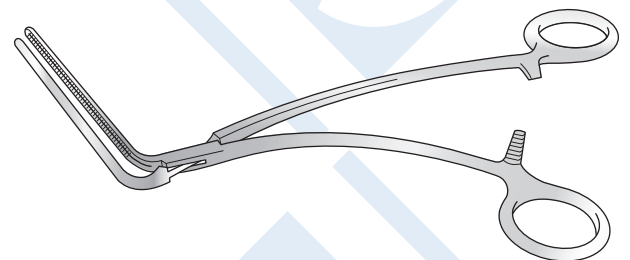

Debakey atraumatic clamp

right-angled, 1/2 serrations, 100mm jaw

SC-THO/047 280mm long

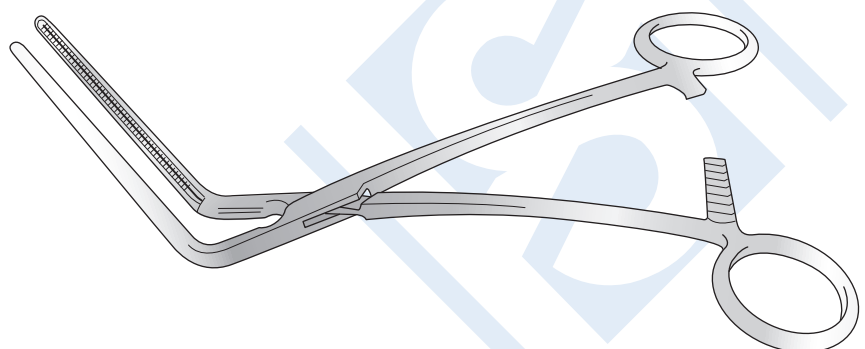

ATRAUMATIC CLAMPS

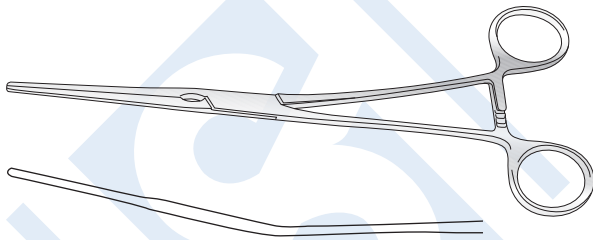

Debakey coarctation clamp
angled, 225mm long

SC-THO/052

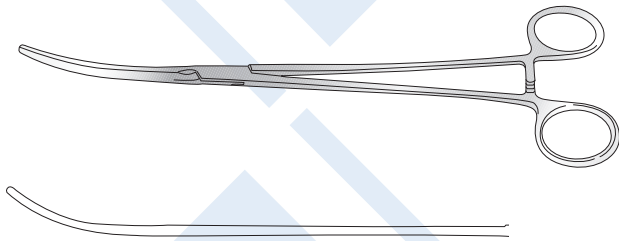
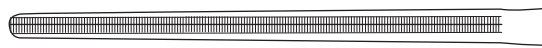

Debakey multi-purpose clamp
obtuse angled 60°, 280mm long

SC-THO/053

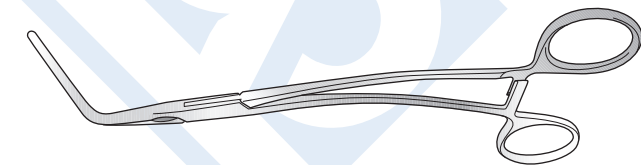
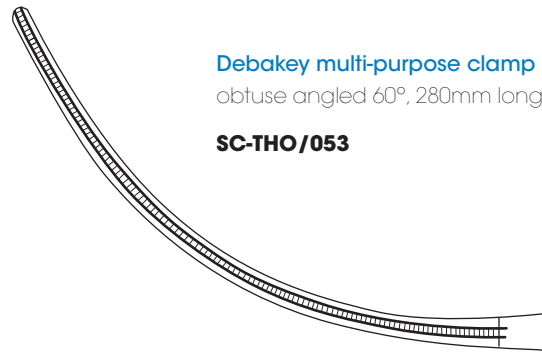

Debakey multi-purpose clamp

SC-THO/095 85mm jaw, 230mm long

SC-THO/064 100mm jaw, 280mm long

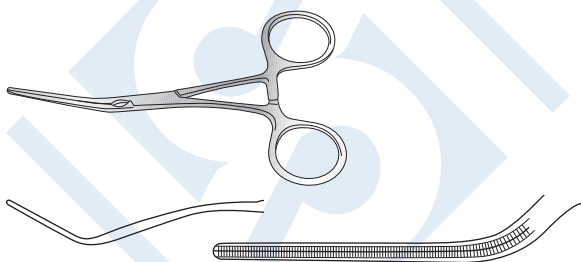
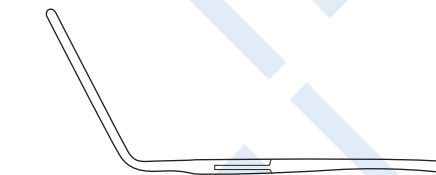

Debakey 45° paed clamp

SC-THO/050 130mm long

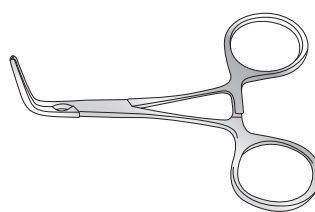

Debakey 90° paed clamp

SC-THO/051 105mm long

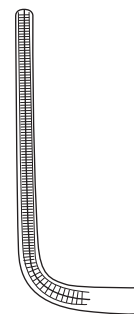

SCISSORS

Potts scissors

satin finish, 190mm long

- SC-THO/019** angled on flat 45°
- SC-THO/020a** angled to side 45°
- SC-THO/020b** acute angle to side

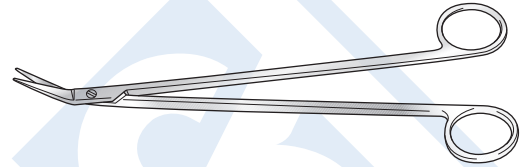

Diethrich circumflex artery scissors

super cut, 175mm long

- SC-THO/077** 125° angled on side

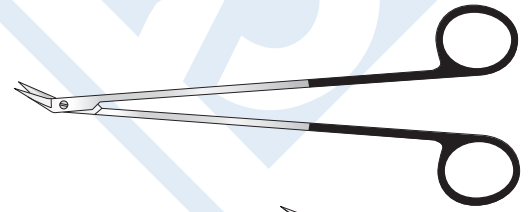

Potts/Diethrich scissors

super cut, 190mm long

- SC-THO/078** 25° angled on side
- SC-THO/079** 45° angled on side
- SC-THO/080** 90° angled on side

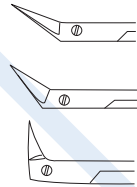

Boyd scissor

supercut, slight curve

- SC-THO/047** 180mm long

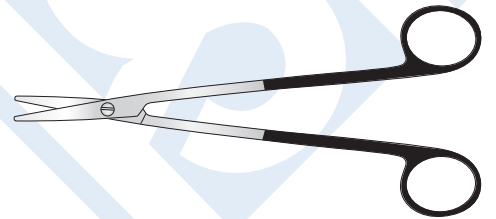

Lobectomy scissors

curved on flat

- SC-THO/001b** 305mm long

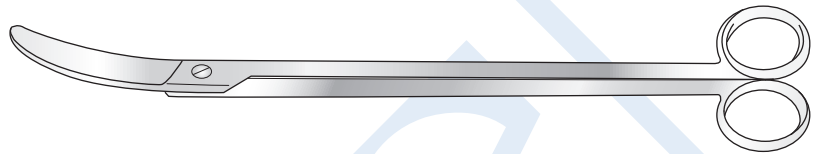

Nelson's lobectomy scissor

tungsten carbide, curved on flat, 230mm long

- SC-THO/057**

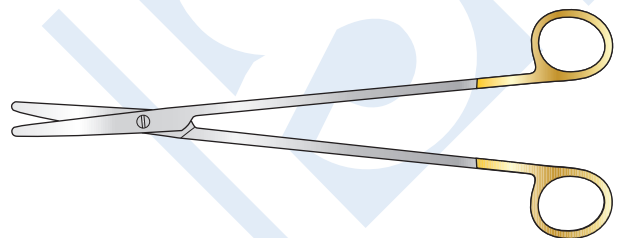

NEEDLE HOLDERS

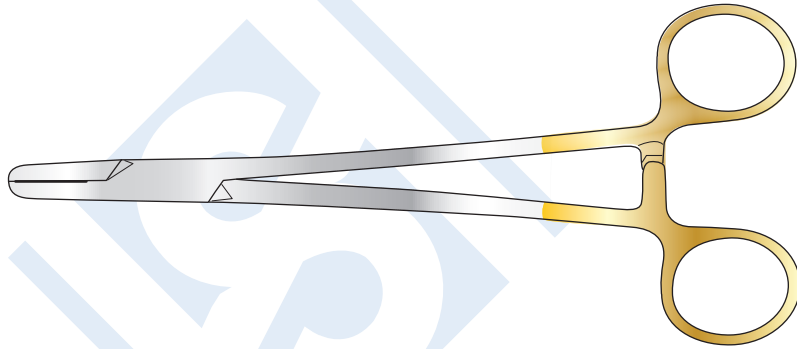

Needle holder and wire twister

for sternum wire, left-handed, 300mm long

SC-THO/083

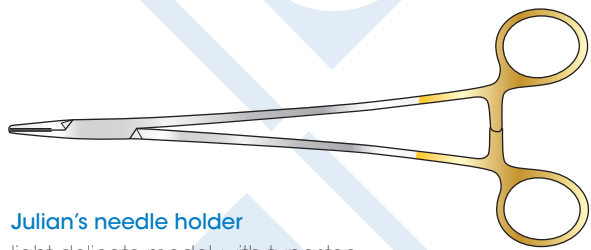

Julian's needle holder

light, delicate model, with tungsten carbide jaws, 220mm long

SC-THO/081

SC-THO/081a left-handed

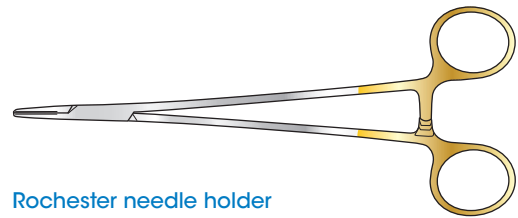

Rochester needle holder

light, delicate model, with tungsten carbide jaws, 190mm long

SC-THO/082

SC-THO/082a left-handed

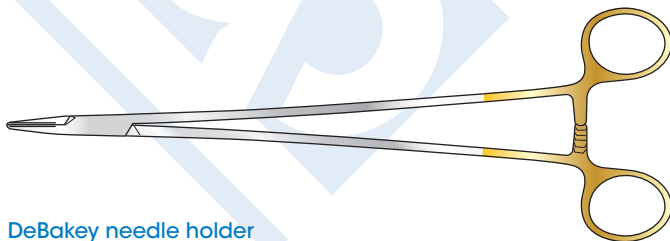

DeBakey needle holder

250mm long

THO/SC-5642a

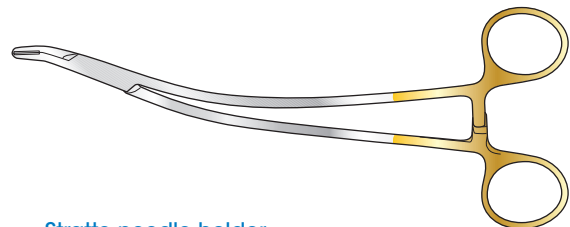

Stratte needle holder

210mm long

THO/SC-5642b



Castroviejo needle holder

without catch

diamond dust jaws

SC-THO/060 180mm long

SC-THO/061 200mm long

SC-THO/062 215mm long

also available with catch - add suffix **cth** to code

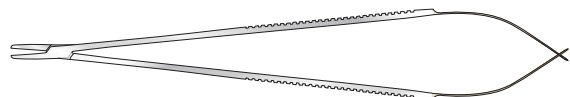

tungsten carbide jaws

SC-THO/058a 180mm long

SC-THO/058 200mm long

SC-THO/059 215mm long

also available with catch - add suffix **cth** to code

RETRACTORS

Blanco valve leaflet retractor

280mm long

SC-THO/041



Harrington Splanchnic retractor

small size, end of blade
38mm wide x 127mm deep,
satin finish handle

SC-THO/011 320mm long

Brocks Erecton spinal back end retractor

215mm long

SC-THO/054 13 x 28mm

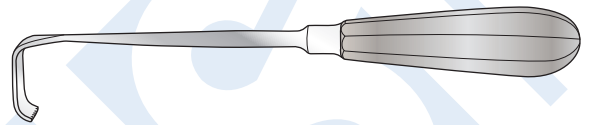

Ross retractor

250mm long

SC-THO/089 16mm X 15mm blade

SC-THO/089a 23mm X 13mm blade

SC-THO/089b 24mm X 16mm blade

SC-THO/089c 27mm X 13mm blade

SC-THO/089d 27mm X 27mm blade

SC-THO/089e 25mm X 38mm blade

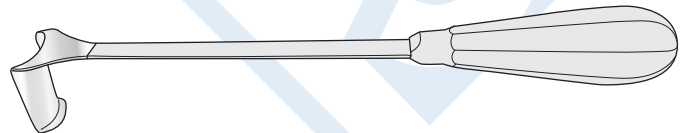

Cleland valve leaflet retractor

250mm long

SC-THO/097

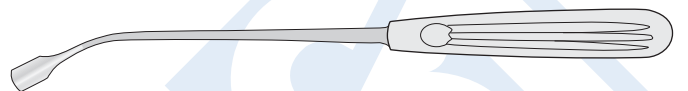

Tudor Edwards retractor

25mm wide

SC-THO/013 205mm long

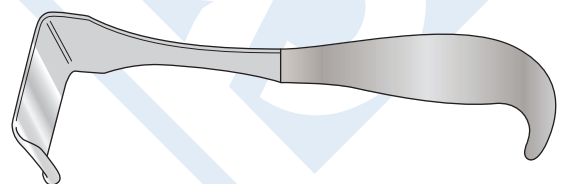

RETRACTORS / RIB SPREADERS

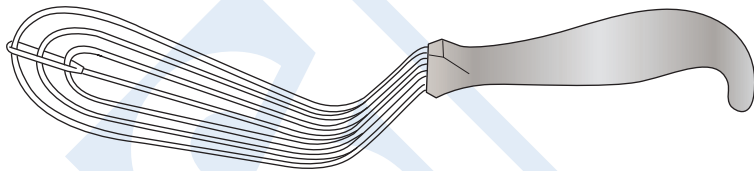

Allison lung retractor

satin finish handle

SC-THO/012a infant

SC-THO/012b child, 280mm blade

SC-THO/012c adult, 300mm blade

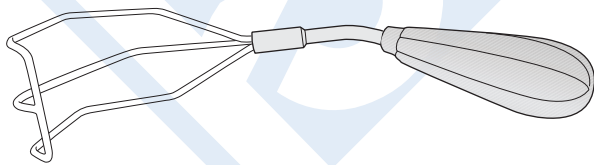

Cooley atrial retractor

260mm overall length

SC-THO/046 right

SC-THO/046a left

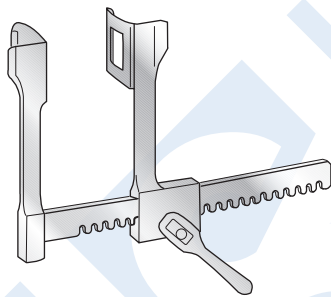

Finochietto rib spreader

straight arms, 20mm square blades

SC-THO/006 infant, maximum opening 80mm,
x 60mm long

SC-THO/037 adult, maximum opening 200mm,
blades 44 x 65mm

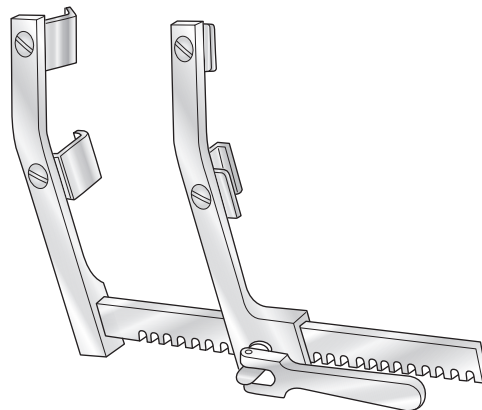

Morse-Favaloro rib spreader

curved arms, 275mm long

SC-THO/103 swivel blades 215mm long

SC-THO/103a swivel blades 185mm long

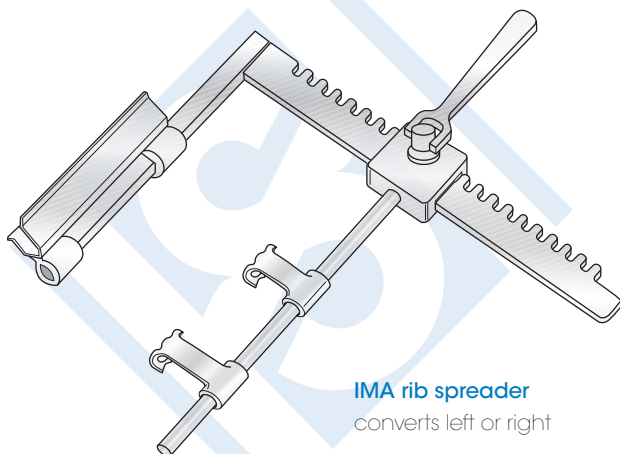

IMA rib spreader

converts left or right

SC-THO/102 standard frame only

SC-THO/102a ministernotomy frame only

SC-THO/102b complete, standard, 1 x frame,
1 x 100mm long x 20mm wide U shaped blade,
1 x claw blades 28mm and 32mm deep

SC-THO/102c complete, ministernotomy, 1 x frame,
1 x 30mm long x 20mm wide U shaped blade,
1 x claw blades 43mm and 50mm deep

claw blade only

SC-THO/102d 28mm deep

SC-THO/102e 32mm deep

SC-THO/102f 38mm deep

SC-THO/102g 43mm deep

SC-THO/102h 50mm deep

U shaped blade only

SC-THO/102i 100mm long x 20mm wide

SC-THO/102j 100mm long x 25mm wide

SC-THO/102k 30mm long x 20mm wide

RIB SPREADERS

Price Thomas rib spreader

- SC-THO/99** complete with 3 pairs of blades, key, 250, 215, 68mm
- SC-THO/99a** blade only, 50mm x 38mm, pair
- SC-THO/99b** blade only, 50mm x 45mm, pair
- SC-THO/99c** blade only, 50mm x 65mm, pair
- SC-THO/99d** nut and bolt for blade only
- SC-THO/99e** frame only
- SC-THO/99f** key only

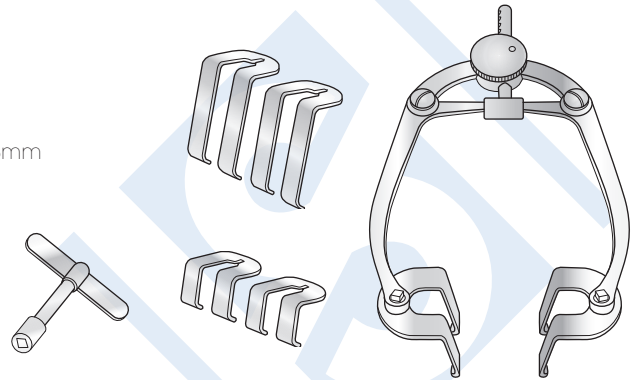

Ronald Edwards rib spreader

curved arms, fenestrated

- SC-THO/104** infant, 100mm, 25mm x 30mm blades
- SC-SH-5158** child, 150mm, 30mm x 50mm blades
- SC-SH-5720** adult, 245mm, 65mm x 75mm blades

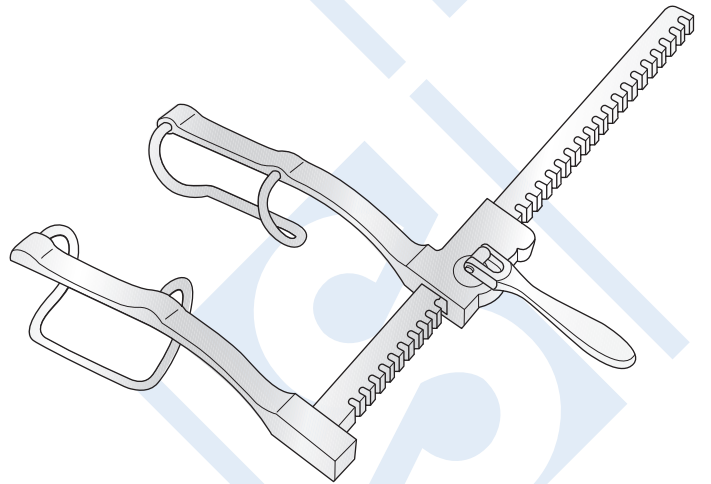

Sellors rib spreader

- SC-THO/100** complete with 3 pairs of blades, key,
- SC-THO/100a** blade only, 50mm x 38mm, pair
- SC-THO/100b** blade only, 50mm x 45mm, pair
- SC-THO/100c** blade only, 50mm x 65mm, pair
- SC-THO/100d** frame only
- SC-THO/100e** nut and bolt for blade only
- SC-THO/100f** key only

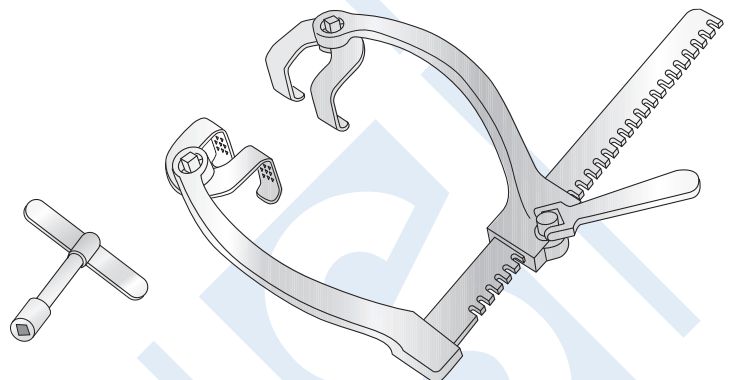

Sellors rib spreader

Harefield sternal blade only, pair

- SC-THO/100g** 70 x 30mm
- SC-THO/100h** 120 x 30mm

Harefield scapula blade only, pair

- SC-THO/100i** 75 x 70mm

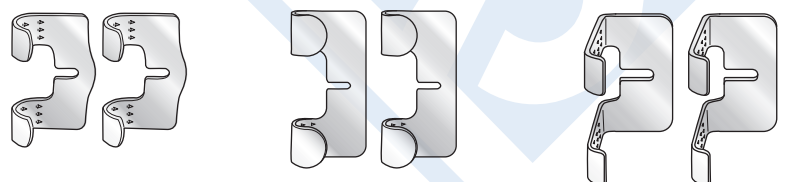

RIB SPREADERS

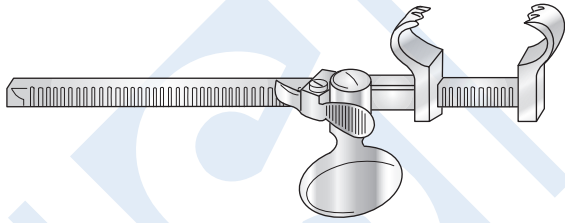

Bailey rib approximator and spreader

combined, satin finish

SC-THO/003 160mm long

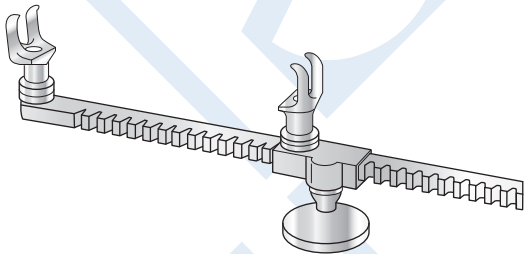

Sellers rib approximator and spreader

combined action, satin finish

SC-THO/002 195mm long

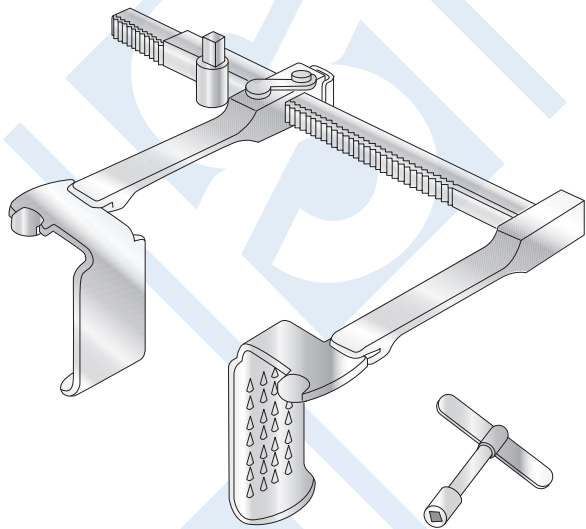

Tudor Edwards rib spreader

SC-THO/101 complete, 2 of each blade, plus key

SC-THO/101a 25mm blade only, pair

SC-THO/101b 50mm blade only, pair

SC-THO/101c 75mm blade only, pair

Tuffier rib spreader

SC-THO/005

blades 25mm deep x 19mm wide

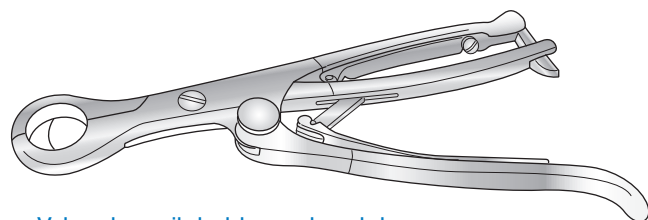
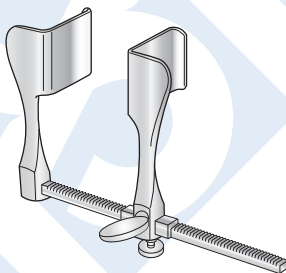

Vehmehren rib holder and costotome

satin finish handles

SC-THO/010 240mm long

RIB SHEARS

Giertz rib shears

SC-THO/041 270mm long

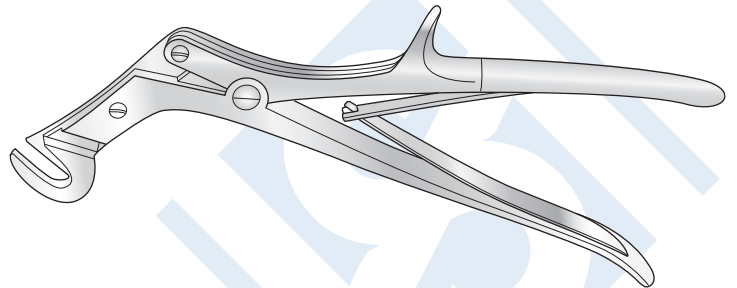

Tudor Edwards rib shears

compound action, anterior

SC-THO/042 235mm long

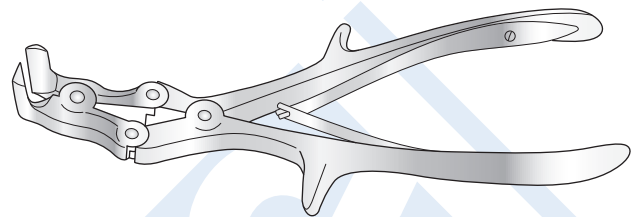

Mayo lung forceps

fenestrated, semi-circular jaw,
satin finish

SC-THO/014 230mm long

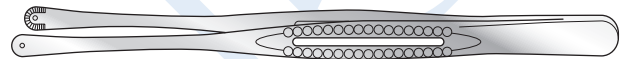

ELEVATORS / MISCELLANEOUS

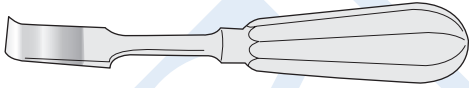

Tudor Edwards periosteal elevator

first rib, 175mm long

SC-THO/009b 18mm wide

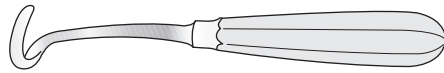

Doyen periosteal elevator

satin finish handle

165mm long

SC-OR/N031 right

SC-OR/N032 left

180mm long

SC-OR/256 right

SC-OR/255 left



Blalock hook

249mm long

SC-THO/042 45°angle, 5mm tip

SC-THO/043b 90°angle, 5mm tip

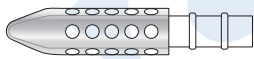

Ross (Papworth) ventricular sucker

33mm long

SC-THO/PAP001 bullet

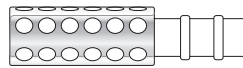

Ross (Papworth) sump sucker

42mm long

SC-THO/PAP002 round end

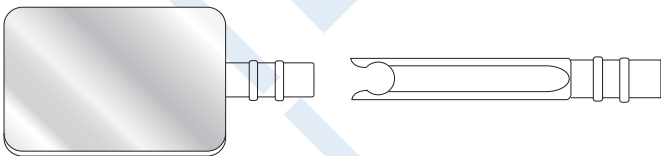

Ross (Papworth) flat sucker

42mm long

SC-THO/PAP003

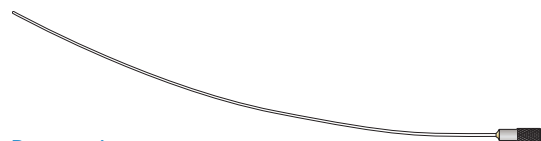

Ross probe

200mm long

SC-THO/055 1mm

SC-THO/055a 1.5mm

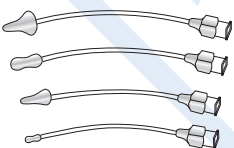

Tibbs arterial cannula

SC-TIB/001 set of four

SC-TIB/002 large cone

SC-TIB/003 large olive

SC-TIB/004 small cone

SC-TIB/005 small olive

GU pattern

SC-TIB/006 large cone

SC-TIB/007 large olive

SC-TIB/008 small cone

SC-TIB/009 small olive

SC-TIB/010 set of four